

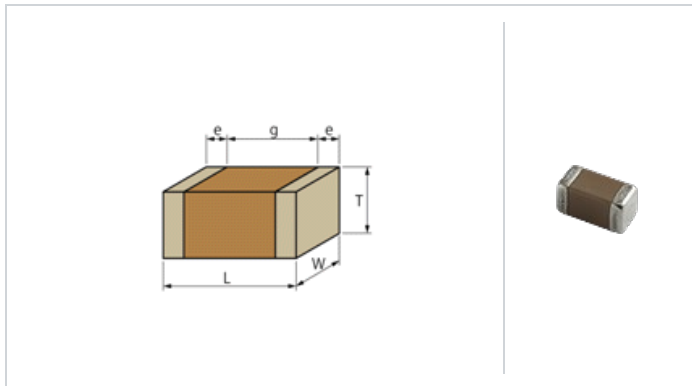

Deadline for last orders: 30 Sep 2018 Date of discontinuation: 31 Dec 2018

< List of part numbers with package codes >
GRM0225C1E8R0DDAEL

Shape



L size	0.4 ±0.02mm
W size	0.2 ±0.02mm
T size	0.2 ±0.02mm
External terminal width e	0.07 to 0.14mm
Distance between external terminals g	0.13mm min.
Size code in inch(mm)	01005 (0402M)

Notes

Please use replacements or Recommended.

References

Packaging	Specifications	Minimum quantity
L	φ180mm Embossed taping	40000

Mass (typ.)	
1 piece	0.09mg
φ180mm Reel	198g

Specifications

Capacitance	8.0pF ±0.5pF
Rated voltage	25Vdc
Temperature characteristics (complied standard)	C0G(EIA)
Temperature coefficient	0±30ppm/°C
Temperature range of temperature characteristics	25 to 125°C
Operating temperature range	-55 to 125°C

Attention

- 1.This datasheet is downloaded from the website of Murata Manufacturing Co., Ltd. Therefore, it's specifications are subject to change or our products in it may be discontinued without advance notice. Please check with our sales representatives or product engineers before ordering.
- 2.This datasheet has only typical specifications because there is no space for detailed specifications. Therefore, please review our product specifications or consult the approval sheet for product specifications before ordering.